

# USER MANUAL



Thank you for choosing Better Bathrooms.  
Please read this manual before installing your product  
and keep for future reference.

**better**   
**bathrooms**

## Product name: Baxenden/Sion/Nero series Bathroom Furniture

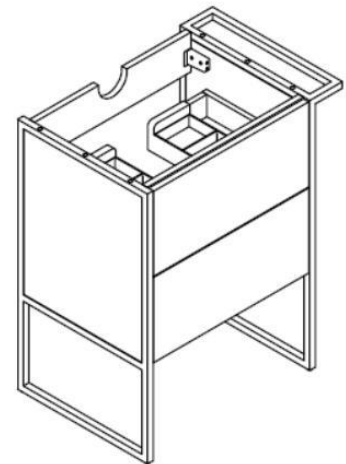
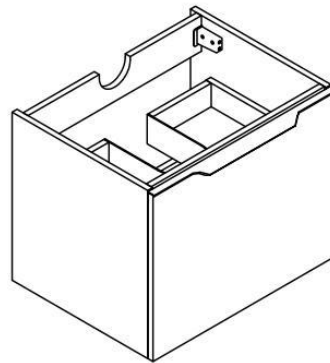

- **Multi-person assembly**
- **Tools required**
- **We always recommend using professional tradespeople to install your product**

V4\_2024.1.16

# Congratulations on your purchase

*And welcome to our growing gang of savvy shoppers*

We're on a mission to bring you extraordinary bathroom products, for less. From modern to traditional style ceramics, plus the gorgeous fixtures, fittings and furniture to match. So, you can fall in love with your space every single day.

As one of the UK's largest independent bathroom stores, we've received countless awards; including the National Business Awards UK, the Digital Entrepreneur Awards and being placed on The Sunday Times Fast Track 100.

We hope your new product goes above and beyond your expectations. However, should any problems occur, please:

- log in to your account and contact our customer services team via your self-serve portal – [betterbathrooms.com/CustomerAccount/Login](https://betterbathrooms.com/CustomerAccount/Login)
- contact us via [betterbathrooms.com/content/contact-us](https://betterbathrooms.com/content/contact-us)

## Important information

- Please read these instructions thoroughly and retain for future reference.
- Always check for pipes and cables before drilling.



# Maximum loading

- Please noted the maximum loading for unit is 100kgs(Including top/basin weight).
- Please noted the maximum loading for each shelf is 30kgs.
- Please noted the maximum loading for each drawer is 15kgs.

# Parts / Diagrams

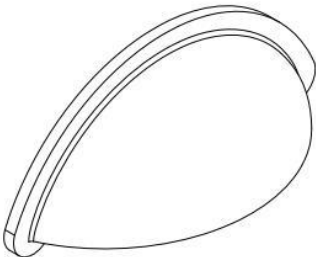

Shell handle



Round handle



Handle screw



Frame screw

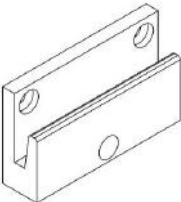

Wall bracket



Wall plug



Wall screw



Plastic washer



Brass washer



Screw cap

## Tools required



Spirit Level



Electric drill



Drill bit



Tape measure  
(3m~5m)



Silicone



Pencil



Screwdriver

## 600mm-900mm Basin Cabinet installation:

The room in which the unit is being installed, must be well ventilated.

Please check for pipes and cables prior to drilling, after the position of the brackets is marked, drill the holes in the wall, using an 8mm drill bit(not supplied), to a depth of approx 50mm.

Insert the wall plugs and tap flush with the wall surface and secure the wall brackets into place.

Check the brackets fitted to the unit are fully tightened.

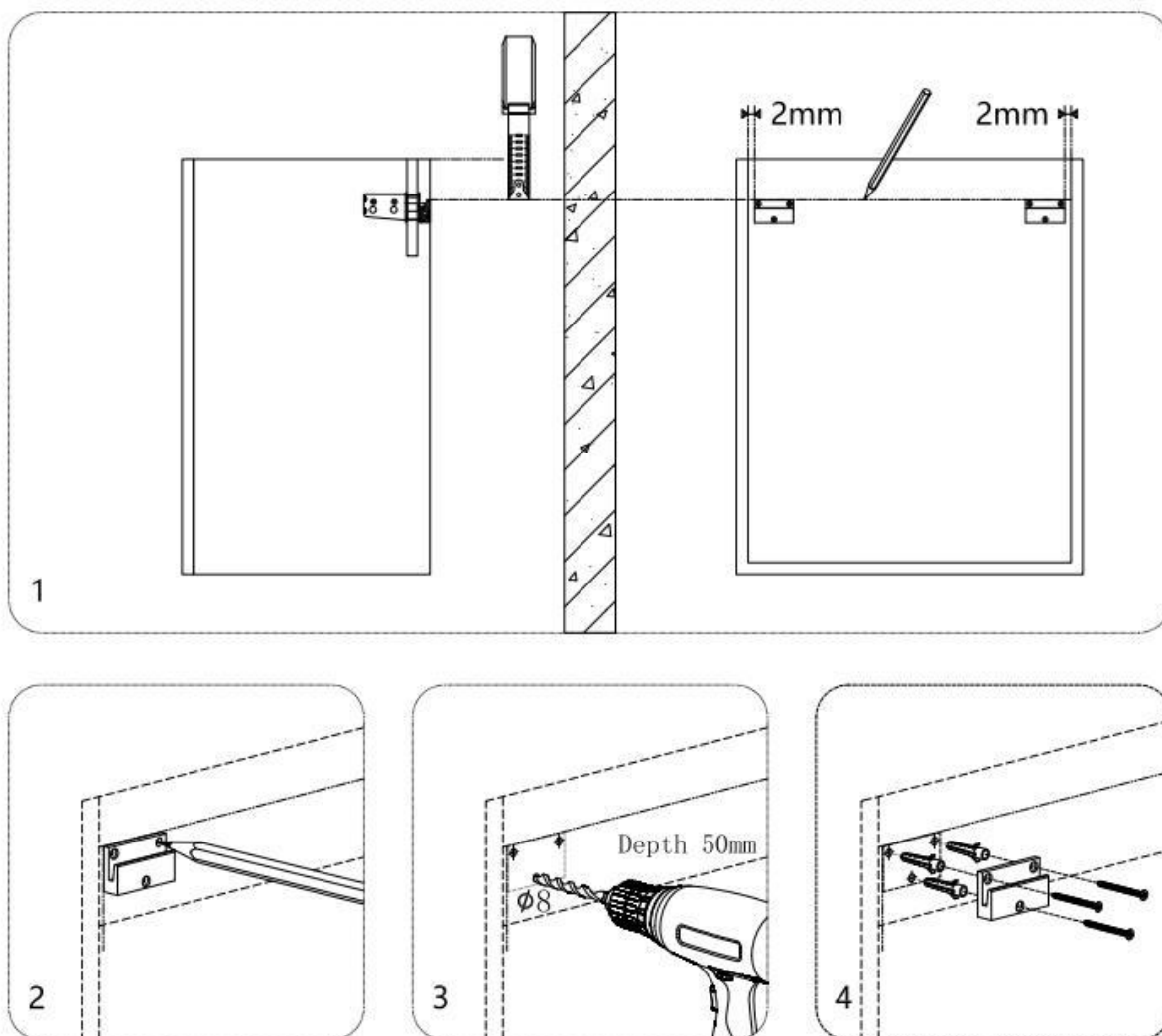

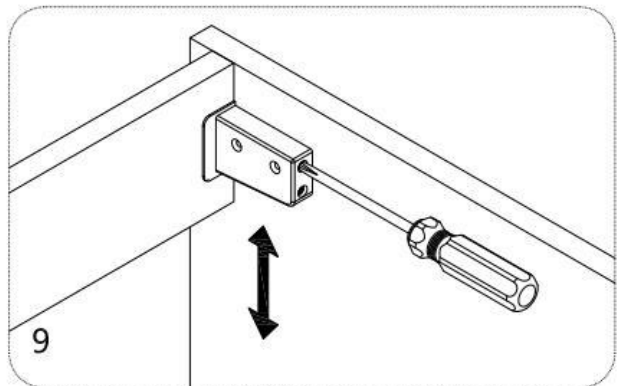
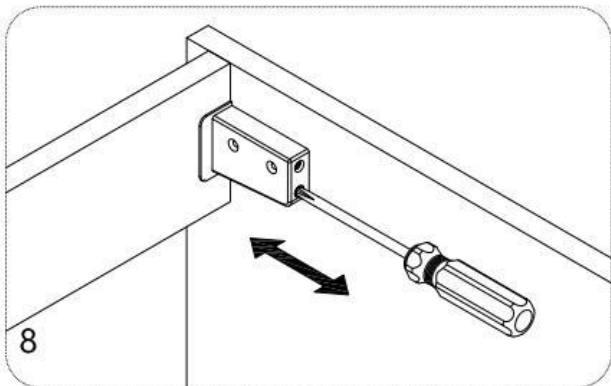
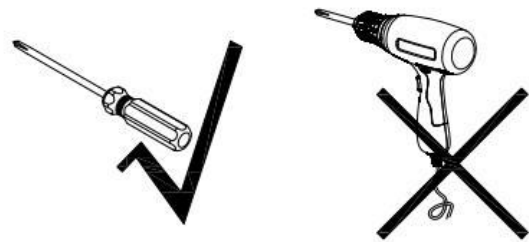
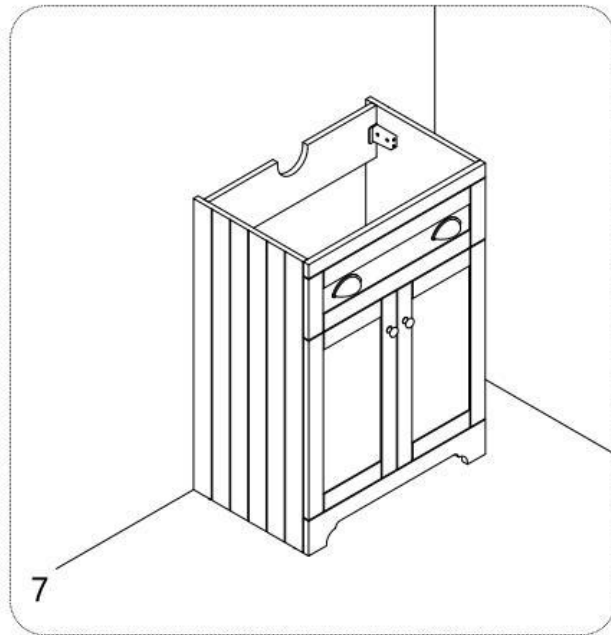
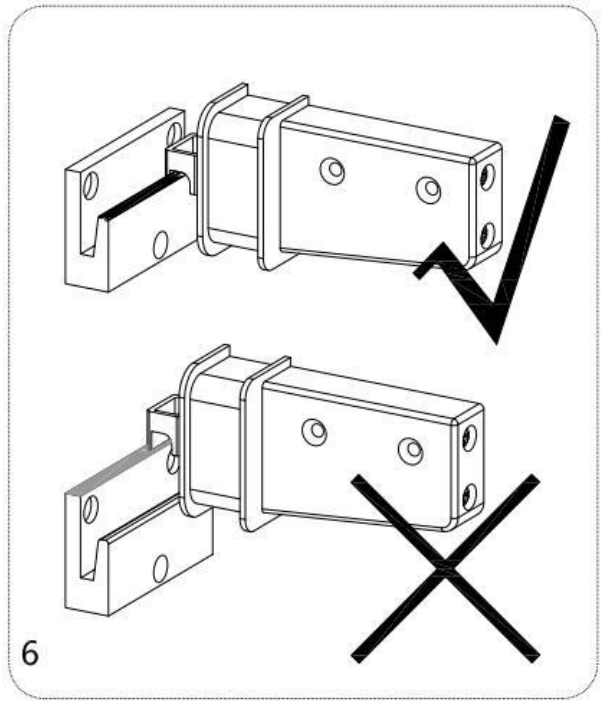
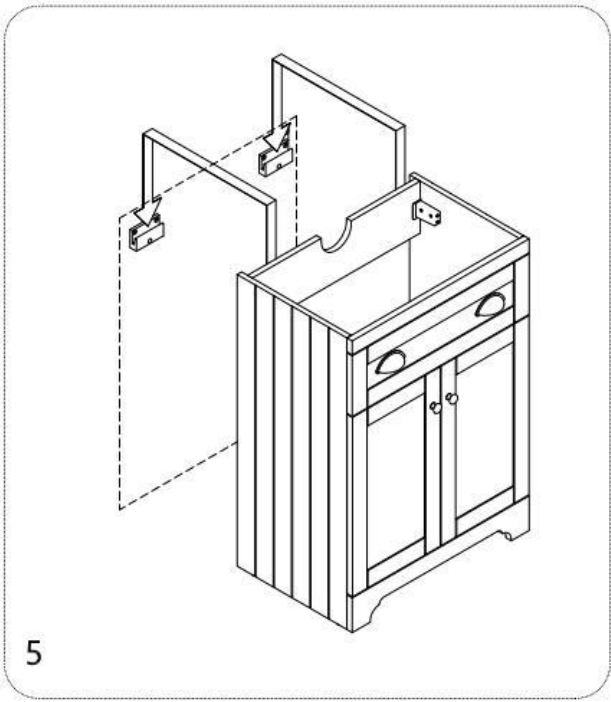

## 400mm-600mm Basin Cabinet installation:

The room in which the unit is being installed, must be well ventilated.

Please check for pipes and cables prior to drilling, after the position of the wall screws are marked, drill the holes in the wall, using an 8mm drill bit(not supplied), to a depth of approx 50mm.

Insert the wall plugs and tap flush with the wall surface and secure the wall screws into place.

Check the wall screws fitted to the unit are fully tightened.

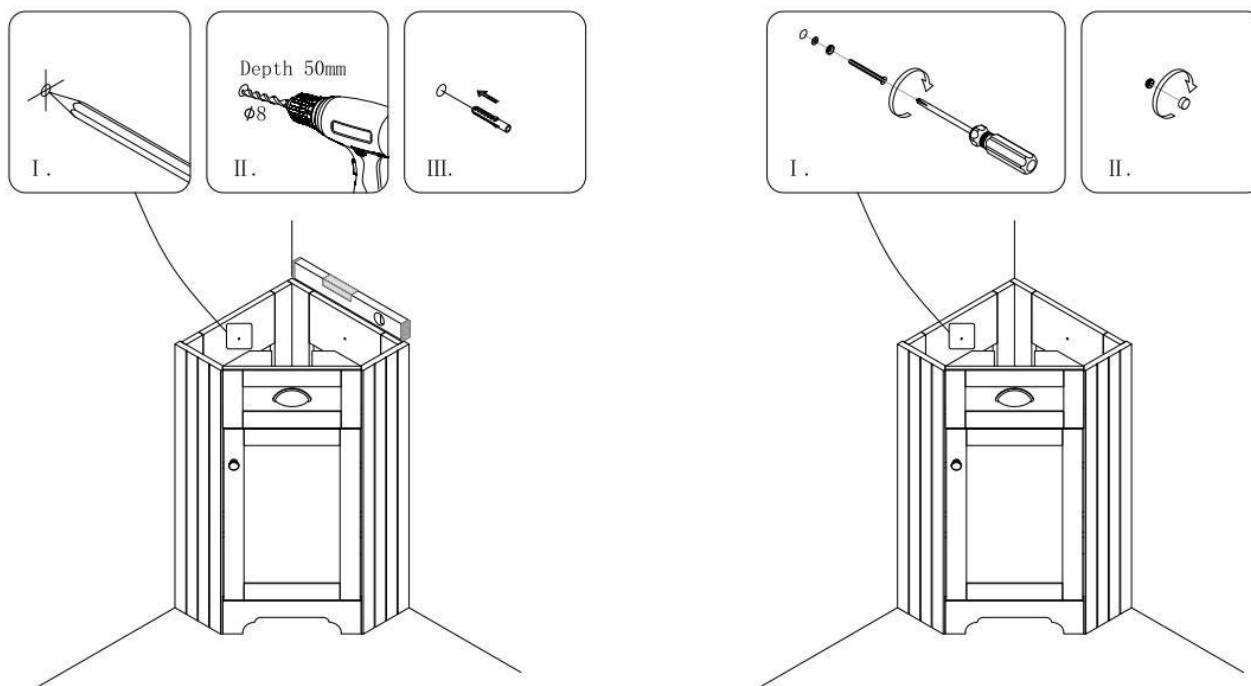



# Side Cabinet installation:

The room in which the unit is being installed, must be well ventilated.

Please check for pipes and cables prior to drilling, after the position of the brackets is marked, drill the holes in the wall, using an 8mm drill bit(not supplied), to a depth of approx 50mm.

Insert the wall plugs and tap flush with the wall surface and secure the wall brackets into place.

Check the brackets fitted to the unit are fully tightened.

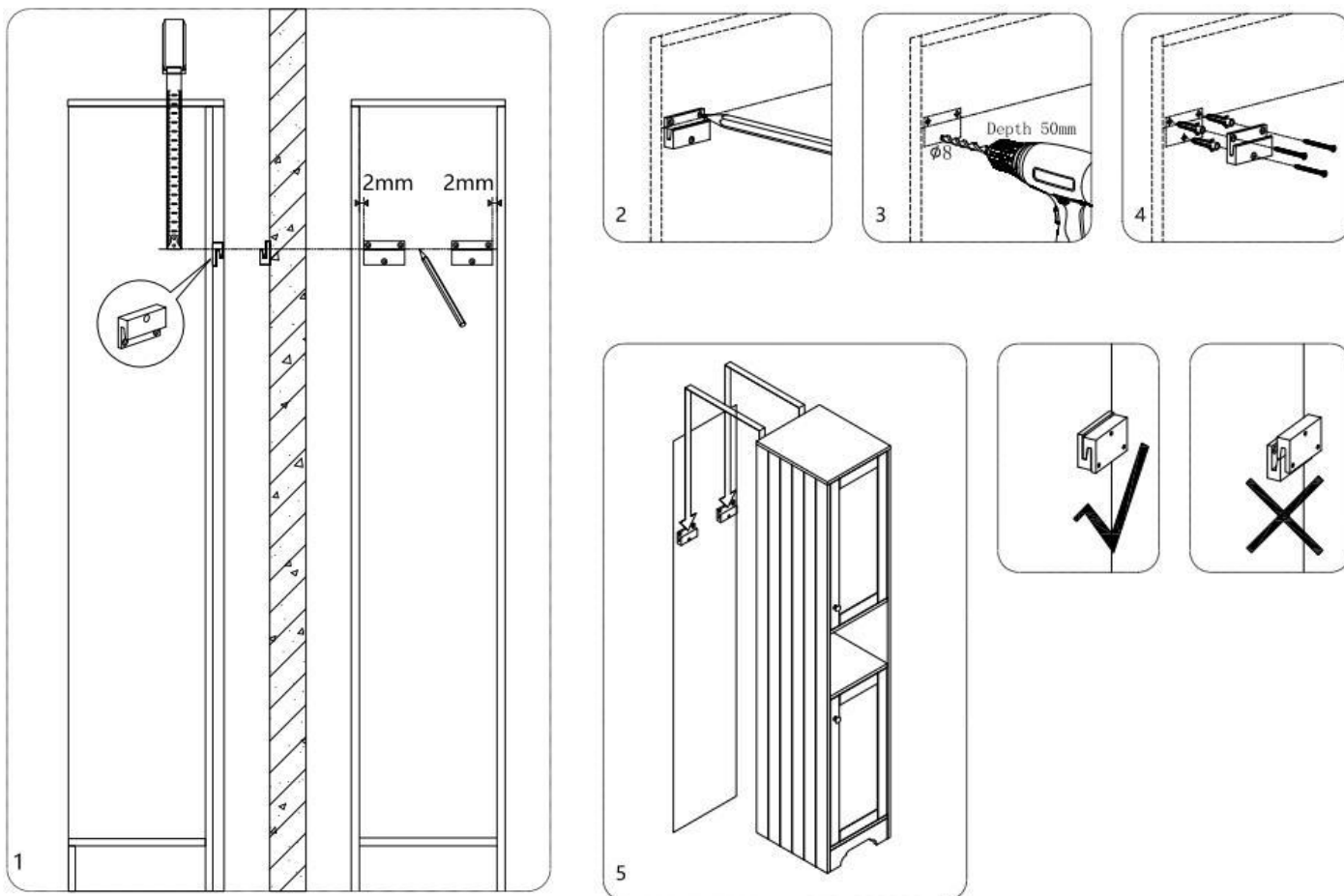

## WC Cabinet installation:

Drill into the wall through the rear plinth of the WC unit.

Fit the wall plug.

Place the screw through the washers and secure to the wall. Fit brass screw cap to brass washer.

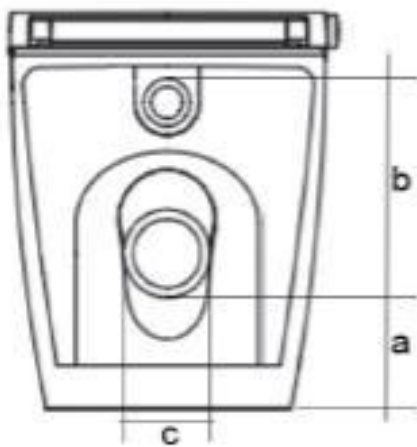
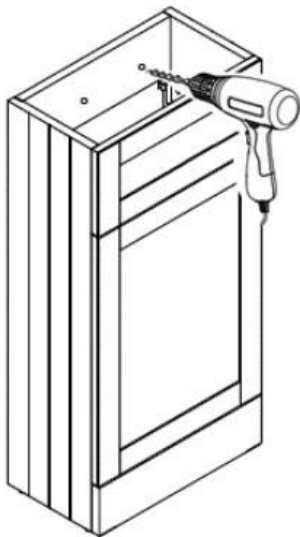

Measure the height from the floor to height a then measure height b and allow 5mm tolerance, then measure width c and allow 5mm

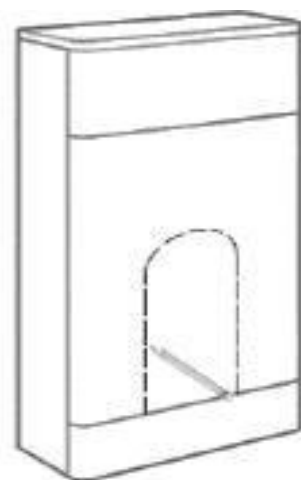

Mark these dimensions on to the front panel of the unit using a pencil

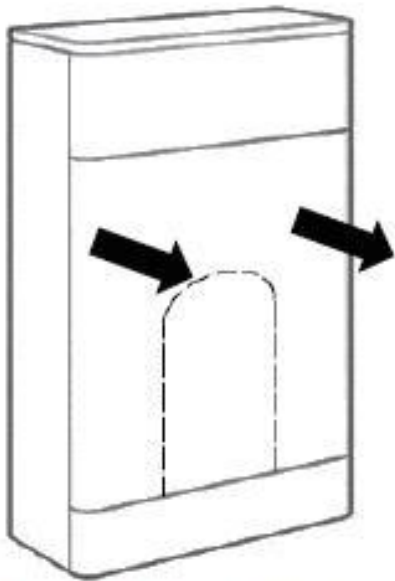

Remove the front panel from the unit and cut the hole to allow the waste pipe and flush pipe to pass from the cistern

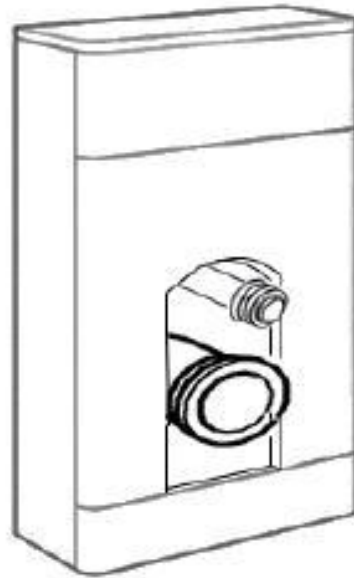

It is recommended to seal the cut edge and bottom edge of the unit, to protect against moisture ingress

## Troubleshooting: DRAWER REMOVAL & INSTALLATION

REMOVAL

INSTALLATION

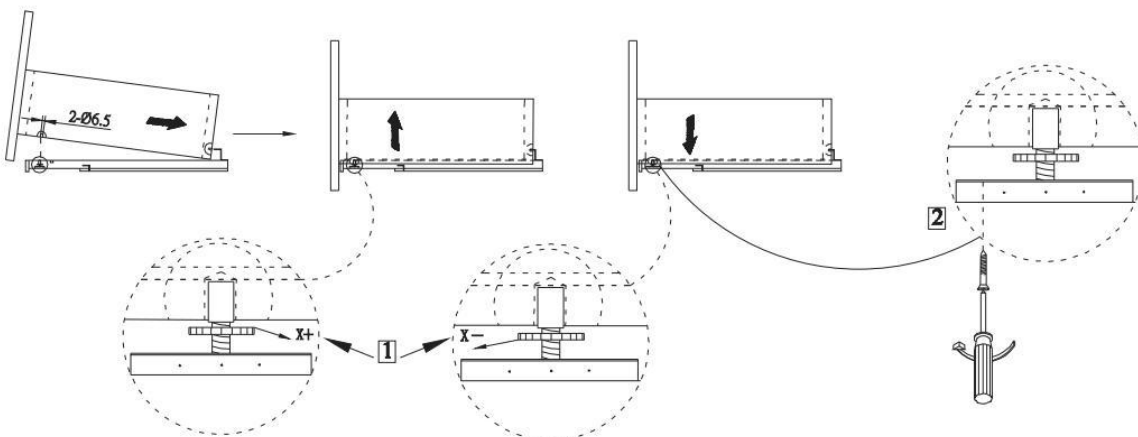

## Door handle installation:

The doors which are to be fitted with handles, either the round or shell type are provided with pilot holes which should be drilled to allow fitting of the handle screw through the door and into the handle.

Drill the holes, then place the screw through the unit from inside the door, connect this to be handle and tighten.

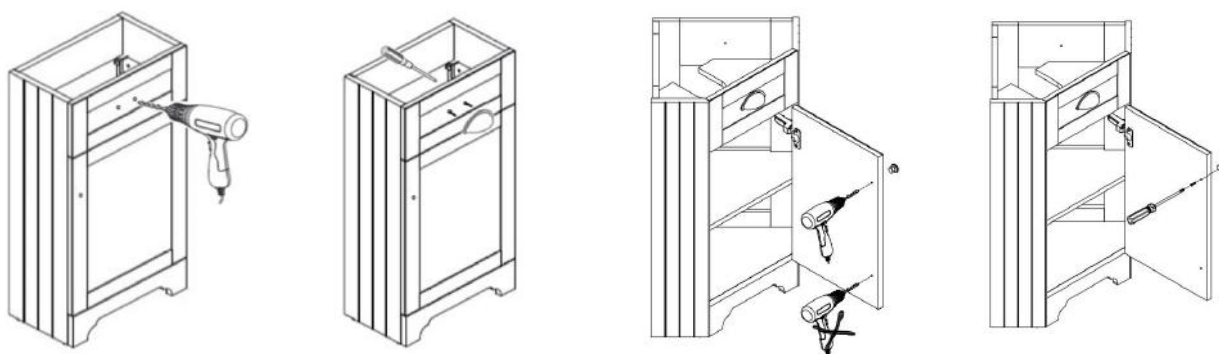

## Framed furniture assembly:

Place the frame onto the unit and screw the frame to the unit through the holes in the frame, ensuring this is aligned with the unit edge.

Ensure this is fully secured before use.

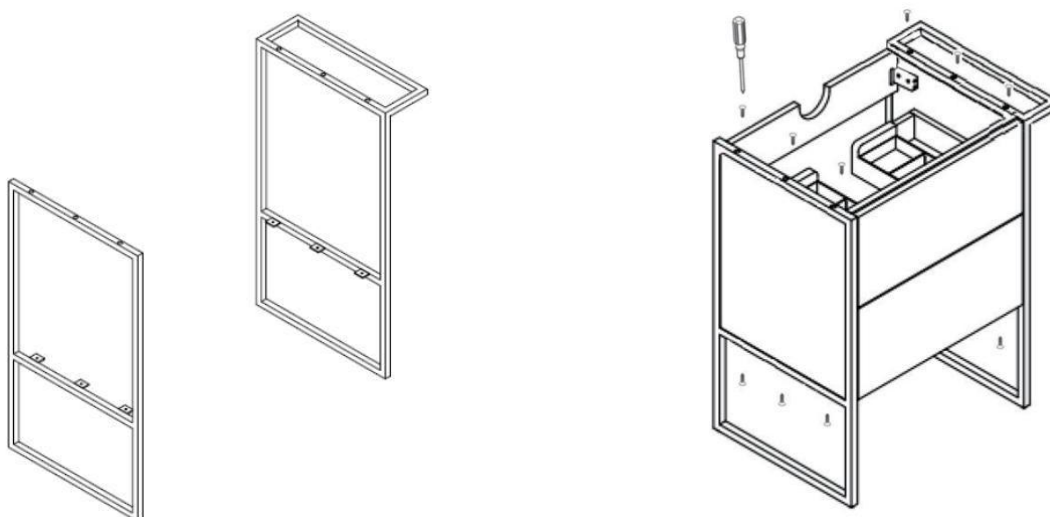

# Maintenance and Cleaning

Wipe the product clean and dry regularly, especially when the product is subject to steam or splashes.

Do not use harsh chemicals or materials on the product, as this will damage the product and invalidate your guarantee.

To clean and maintain the product, wipe using a clean damp cloth and wipe dry with a soft cloth.

## ***For more information***

- visit [betterbathrooms.com](http://betterbathrooms.com)
- email [customerservices@buyitdirect.co.uk](mailto:customerservices@buyitdirect.co.uk)
- call 0330 390 3062
- write to Trident Business Park, Neptune Way, Huddersfield, HD2 1UA

**better**   
**bathrooms**

Part of the BuyItDirect Group